

## VMC ÇATI TİPİ MUTFAK FANLARI VMC ROOF TYPE KITCHEN FANS

VENCO VMC Çatı Tipi Mutfak Fanları, özellikle mutfak havalandırmasında tercih edilmesine rağmen, farklı uygulamalar için de tercih edilmektedir. Motorun hava akımı dışında olması nedeniyle, motor yüksek sıcaklıkta ve yağlı egzoz havasına maruz kalmamaktadır.

- Motor hava akımı dışında
- Yüksek verimli geriye eğik alüminyum kanatlı fanlar
- Class F izolasyon sınıfı ve IP55 koruma sınıfı, direk akuple motor
- Frekans dönüştürücü ile %25 - %100 aralığında hız kontrolü
- Kolay montaj ve bakım imkanı sağlayan tasarım

VENCO VMC Roof Type Kitchen Exhaust Fans are especially used for kitchen applications besides in different usage. Motor is outside the hot temperature and oily air stream which is extracted from the kitchen.

- Motor is outside the air stream
- High efficiency direct driven aluminum impeller plug fans
- Class F isolation and IP55 protection class, direct driven motors
- Speed control with the frequency convertor between 25%-100%
- The design provides fast and easy installation and maintenance



HAVA DEBİSİ (m<sup>3</sup>/h) / Air Flow

Statik Basınç Pressure Drop (Pa)	VMC 350	VMC 400	VMC 450	VMC 500	VMC 560	VMC 630	VMC 710	VMC 800
50								
75								
100								
125	3.083	4.237						
150	2.981	4.137		7.819	11.229	16.207	23.218	38.000
175	2.874	4.028	5.586	7.705	11.101	16.074	23.061	37.715
200	2.755	3.914	5.453	7.586	10.968	15.937	22.909	37.430
225	2.622	3.795	5.315	7.462	10.835	15.794	22.753	37.276
250	2.475	3.662	5.178	7.334	10.697	15.651	22.591	37.122
275	2.304	3.520	5.030	7.206	10.555	15.504	22.430	36.968
300	2.100	3.363	4.881	7.068	10.412	15.357	22.268	36.813
325	1.834	3.192	4.722	6.930	10.265	15.205	22.102	36.597
350	1.425	2.994	4.555	6.788	10.118	15.048	21.931	36.381
375		2.765	4.380	6.641	9.961	14.891	21.760	36.166
400		2.489	4.199	6.484	9.799	14.730	21.584	35.950
425		2.109	4.000	6.322	9.638	14.564	21.413	35.734
450			3.781	6.151	9.467	14.397	21.233	35.519
475			3.553	5.976	9.291	14.226	21.052	35.303
500			3.287	5.786	9.111	14.051	20.867	35.087
550			2.594	5.368	8.731	13.685	20.492	34.872
600				4.893	8.313	13.300	20.097	34.438
650				4.285	7.866	12.892	19.694	34.041
700				3.411	7.353	12.455	19.266	33.645
750					6.774	11.989	18.829	33.250
800					6.080	11.486	18.373	32.775
850					5.197	10.925	17.889	32.234
900					3.781	10.317	17.385	31.695
950						9.614	16.844	31.069
1000						8.788	16.274	30.616
1050						7.762	15.656	30.076
1100						6.270	14.991	29.495
1150							14.260	28.952
1200							13.452	28.341
1250							12.540	27.550
1300							11.448	26.636
1350							10.070	25.723
1400							7.980	24.809

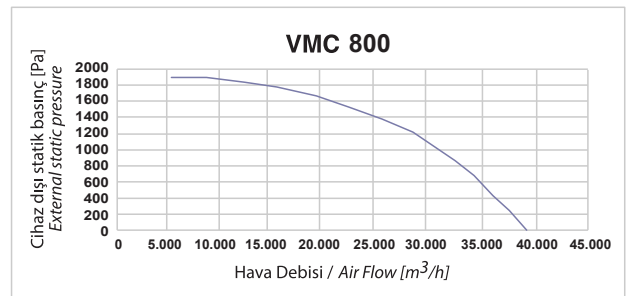
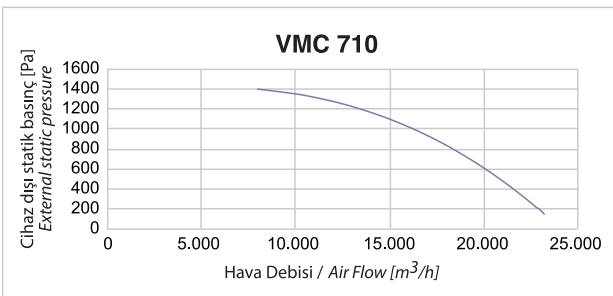
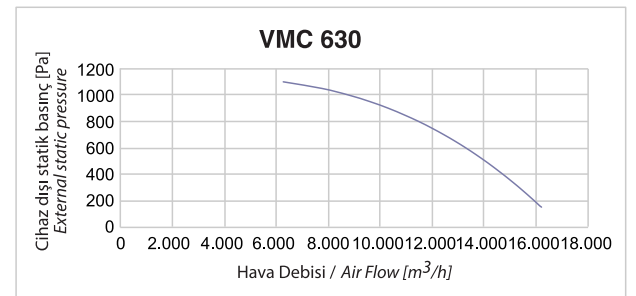
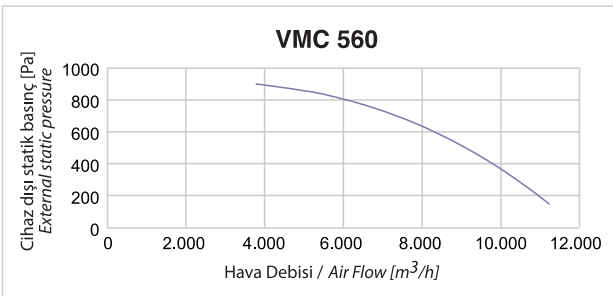
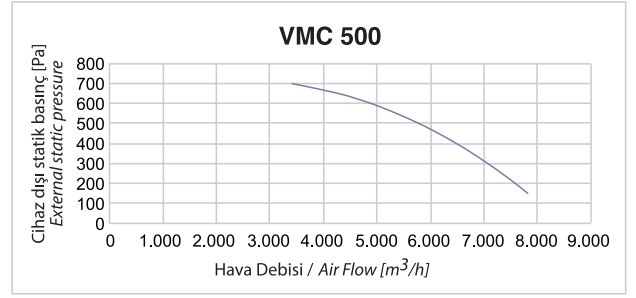
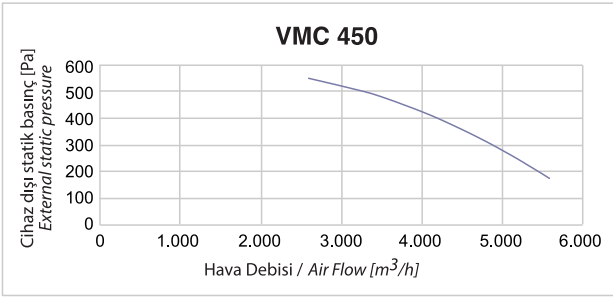
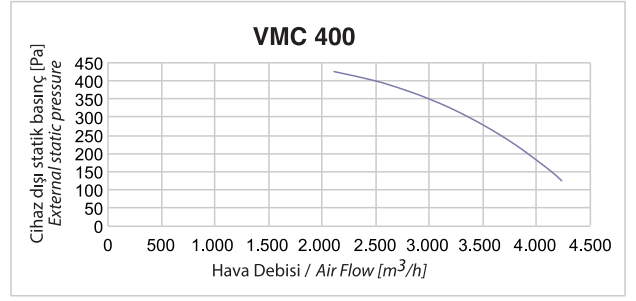
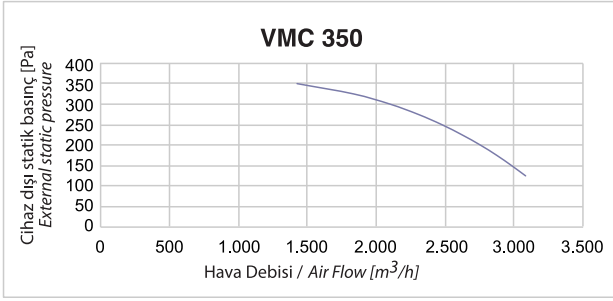

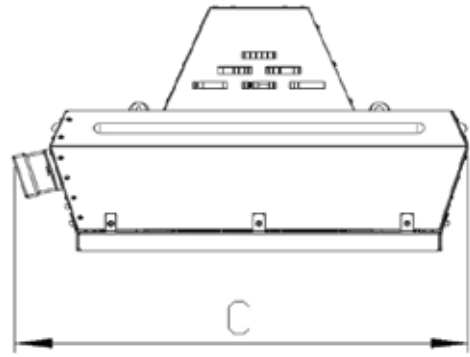
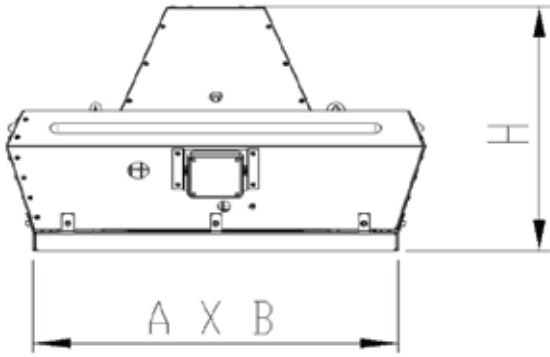

Teknik Özellik Specification	VMC 350	VMC 400	VMC 450	VMC 500	VMC 560	VMC 630	VMC 710	VMC 800
<b>Voltaaj / Voltage (V)</b>	400	400	400	400	400	400	400	400
<b>Güç / Power (kW)</b>	0,37	0,75	1,1	1,5	3	5,5	7,5	15
<b>Akım / Current (A)</b>	1,2	2,2	2,7	3,4	6,7	10,5	14,7	30,4
<b>Devir / rpm</b>	1500	1500	1500	1500	1500	1500	1500	1500
<b>Ağırlık / Weight (kg)</b>	46,2	55,5	68	78,4	103,4	132	158,5	310
<b>A (mm)</b>	640	705	760	810	848	904	938	1109
<b>B (mm)</b>	640	705	760	810	848	904	938	1109
<b>C (mm)</b>	800	870	930	990	1067	1120	1180	1381
<b>H (mm)</b>	528	582	598	659	790	880	955	1206