

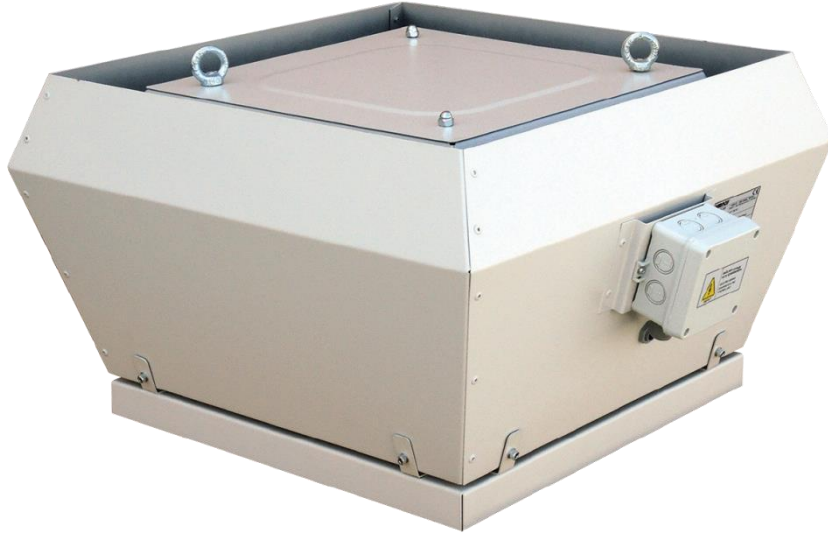

# INSTALLATION – OPERATION – MAINTENANCE MANUEL

## ROOF TYPE FANS

CE



**VENCO Havalandırma ve Makina San.ve Tic. A.Ş.**

2004. Cad. No:5 45400 OSB Turgutlu – MANİSA / TÜRKİYE

Tel: 0090 (236) 332 5070 Fax: 0090 (236) 332 5030

[www.venco.com.tr](http://www.venco.com.tr) [venco@venco.com.tr](mailto:venco@venco.com.tr)

**INDEX**

1. INTRODUCTION..... 1

2. GENERAL IDENTIFICATION OF DEVICE TYPE and MODEL ..... 2

3. INSTALLATION..... 2

4. OPERATION..... 3

5. HANDLING..... 3

6. MAINTENANCE ..... 3

7. FAULT DETECTION ..... 3

8. WARRANTY..... 4

9. ANNEX..... 5

9.1. Annex-1: 1 Phase Electrical Wiring Diagrams ..... 5

9.2. Annex-1: 3 Phase Electrical Wiring Diagrams ..... 6

**1. INTRODUCTION**

Before operating VENCO branded VCF Roof Type Fans, please examine carefully the instruction manual and keep it. Do not use devices as a workbench or a storage area. VENCO VCF Roof Type Fans can only be operated in conditions of intended design and technical specifications.



**BEFORE OPERATING READ THIS MANUEL and KEEP IT IN REACH OF A SERVICE PERSONNEL.**



**THIS DEVICE CAN ONLY BE OPERATED IN CONDITIONS OF INTENDED DESIGN AND TECHNICAL SPECIFICATIONS. OTHERWISE THE RESPONSIBILITY BELONGS TO APPLIER.**



**DO NOT USE THIS DEVICE IN EXPLOSIVE and CORROSIVE ENVIRONMENT.**



**RESPONSIBILITY OF THE DEFECTS WHICH CAN BE OCCURED AS A RESULT OF UNAUTHORIZED PERSONNEL INTERVENTION TO DEVICE or TO BE USED NON-ORIGINAL SPARE PARTS BELONGS TO APPLIER.**

## 2. GENERAL IDENTIFICATION OF DEVICE TYPE and MODEL

The fan is used for transportation of “clean” air, meaning not intended for fire-dangerous substances, explosives, grinding dust, soot, etc. In all models, the body is made of galvanized steel sheet and epoxy coated. Fans are used asynchronous external rotor motors. The fan can be installed outside without water precaution.

## 3. INSTALLATION

The fan must be installed on flat or 15° an inclined roof base without any accessories. If there is more incline, you can install it with the roof curb. In the installation process, you should assembly the fan by screwing every corner of the fan frame with at least two 4,8x19 trapeze screws. The fan should be installed in a way that makes service and maintenance easy. A wiring diagram is applied on the inside of the junction box or separately enclosed. Electrical installations must be made by an authorized electrician. The fan is installed and connected electrically in the right way grounded and with motor protection.

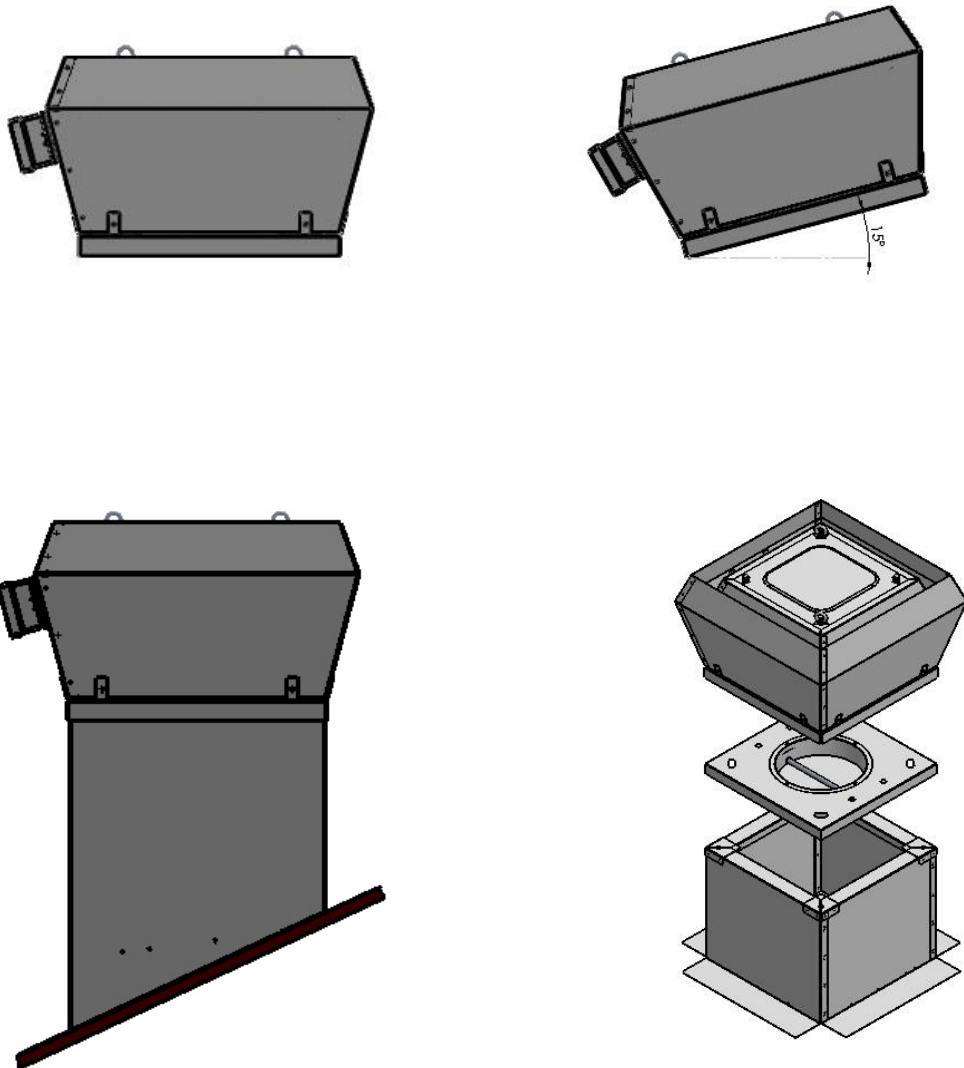



**ALL ELECTRICAL CONNECTIONS SHALL BE DONE ACCORDING TO EN 60204-1 BY TRAINED AND AUTHORIZED PERSONNEL.**



**JUNCTION BOX IS LOCATED ON ALL FANS. SOCKET, SOCKET FUSE and CABLE SECTION MUST BE SELECTED SUITABLE FOR DEVICE CAPACITY**



**DEVICE ABSOLUTELY MUST BE GROUNDED. DEVICE EARTH CONNECTION MUST BE DONE ON TOP OF THE CONNECTOR IN JUNCTION BOX and FROM GROUNDING SCREW WITHIN BODY.**

#### **4. OPERATION**

Before starting, make sure that: the current does not exceed more than +5% of what is stated on the label, no noise appears when starting the fan.

#### **5. HANDLING**

The fan must be transported in its packing until installation. This prevents transport damages, scratches and the fan from getting dirty. Look out for sharp edges and corners.

#### **6. MAINTENANCE**

Before service, maintenance or repair begins, the fan must be tension free and the impeller must have stopped. Before service, maintenance or repair begins, the fan must be tension free and the impeller must have stopped. The fan must be cleaned when needed, at least once per year to maintain the capacity. The fan bearings are maintenance-free and should be renewed only when necessary. When cleaning the fan, high-pressure cleaning or strong dissolvent must not be used. Cleaning should be done without dislodging or damaging the impeller. Make sure that there is no noise from the fan.

#### **7. FAULT DETECTION**

It is necessary to turn off the fan before checking the fan and the system. During maintenance, device electrical connections should be cut entirely. All switches and circuit breakers should be locked by brought to the OFF position. Also "DO NOT START" sign should be placed on the control panel that will consistently stand.

Make sure that the fan blade is not blocked by an object, and in motor fan make sure the capacitor is connected according to the wiring diagram; if fan is still not working, replace the condenser; the problem is still not resolved, contact your supplier fans. In the case of the fan returned to the supplier, make sure that the fan is clean, the connection cable is undamaged and error report is attached to the fan.

## 8. WARRANTY

The warranty period starts from the date of delivery and it is for 2 years. Including all parts of the entire fan is covered by our warranty. In case of malfunction within the warranty period, repair time is added to the warranty period. The repair time is at most 30 business days. This period starts from the date of notification to us. Fan's warranty does not include on-site installation performed by the receiver, electrical connection errors, failures that may arise due to voltage and user errors. The warranty is only valid under condition that the fan is assembled, operated and periodic maintenance to be made according to this manual.

9. ANNEX

9.1. Annex-1: 1 Phase Electrical Wiring Diagrams

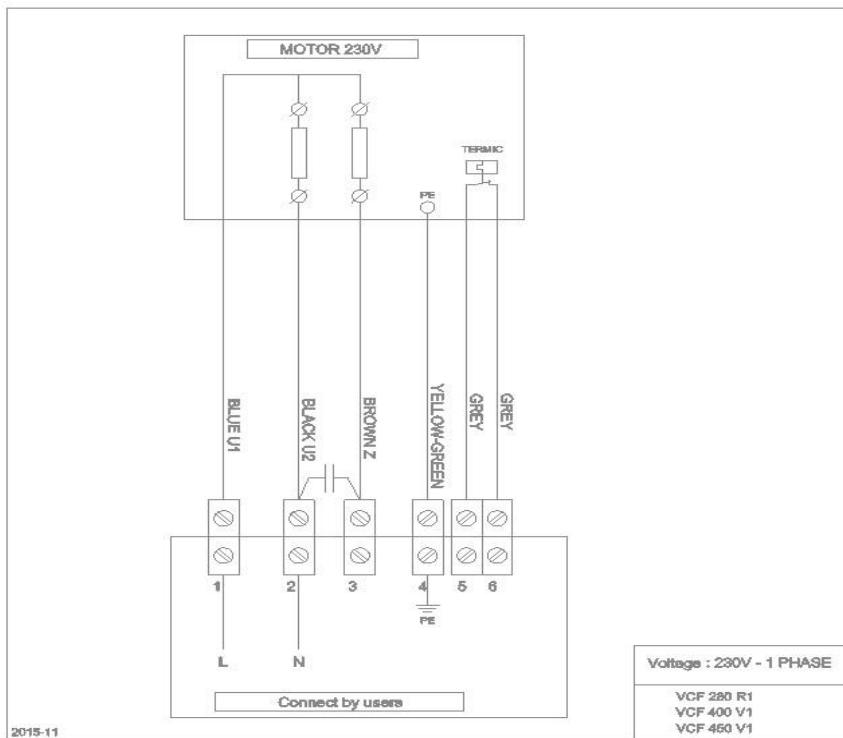
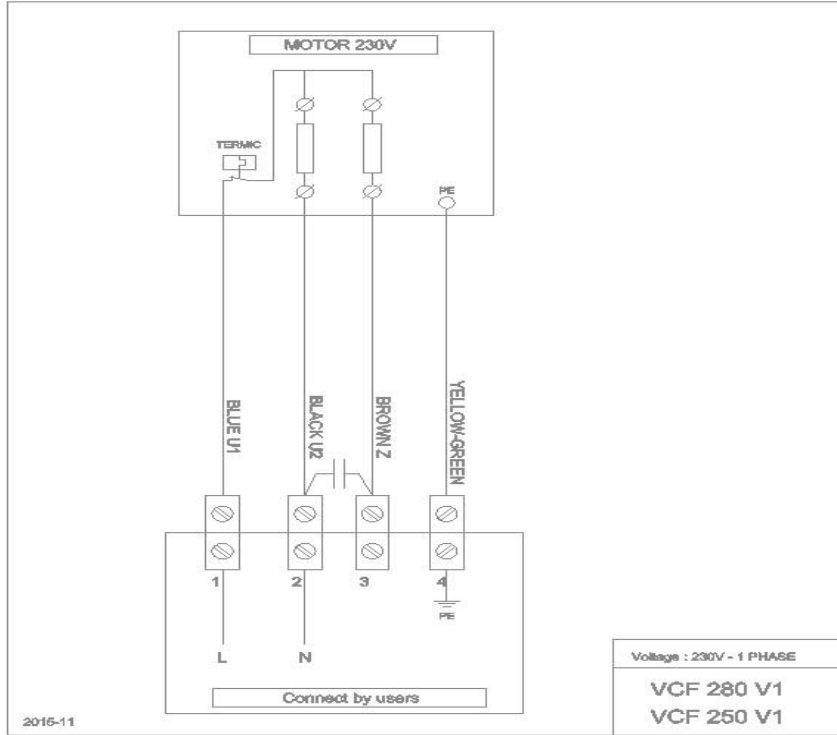

9.2. Annex-2: 3 Phase Electrical Wiring Diagrams

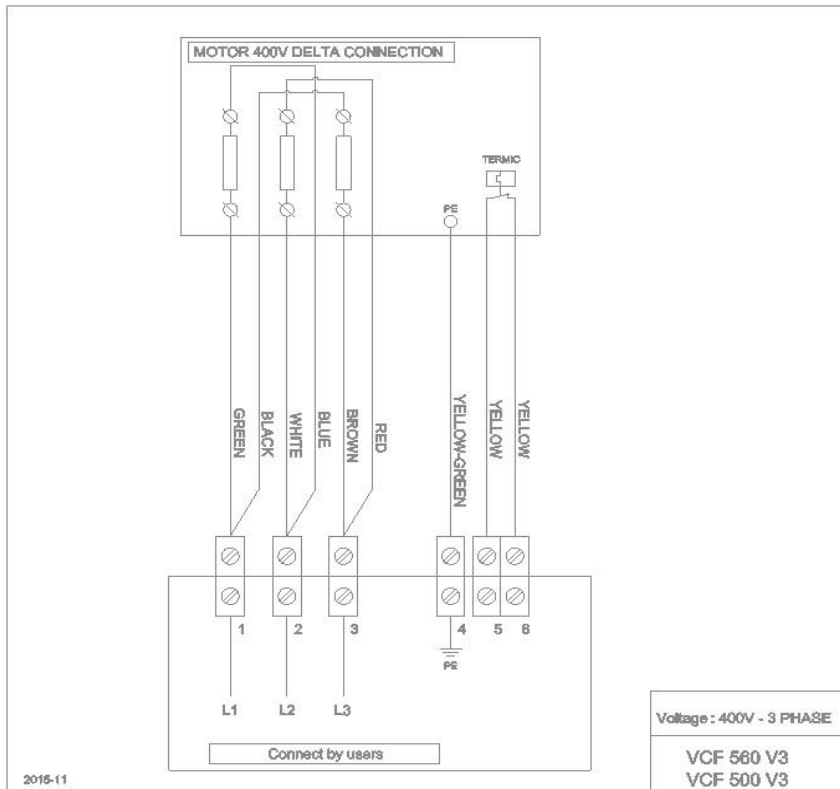
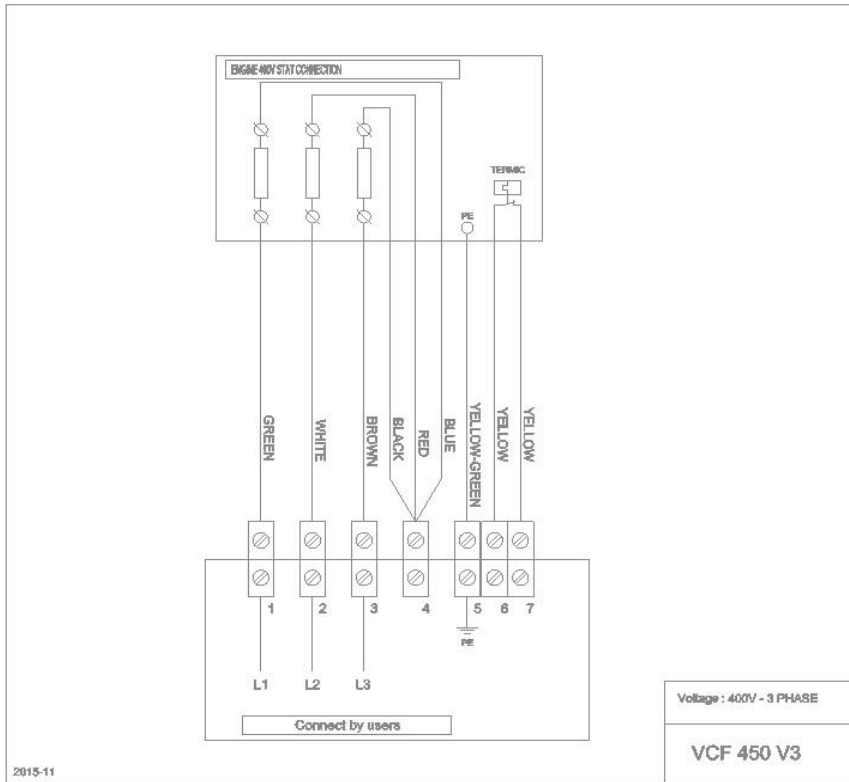

### 9.3. Annex-3: 1 Phase EC Electrical Wiring Diagrams

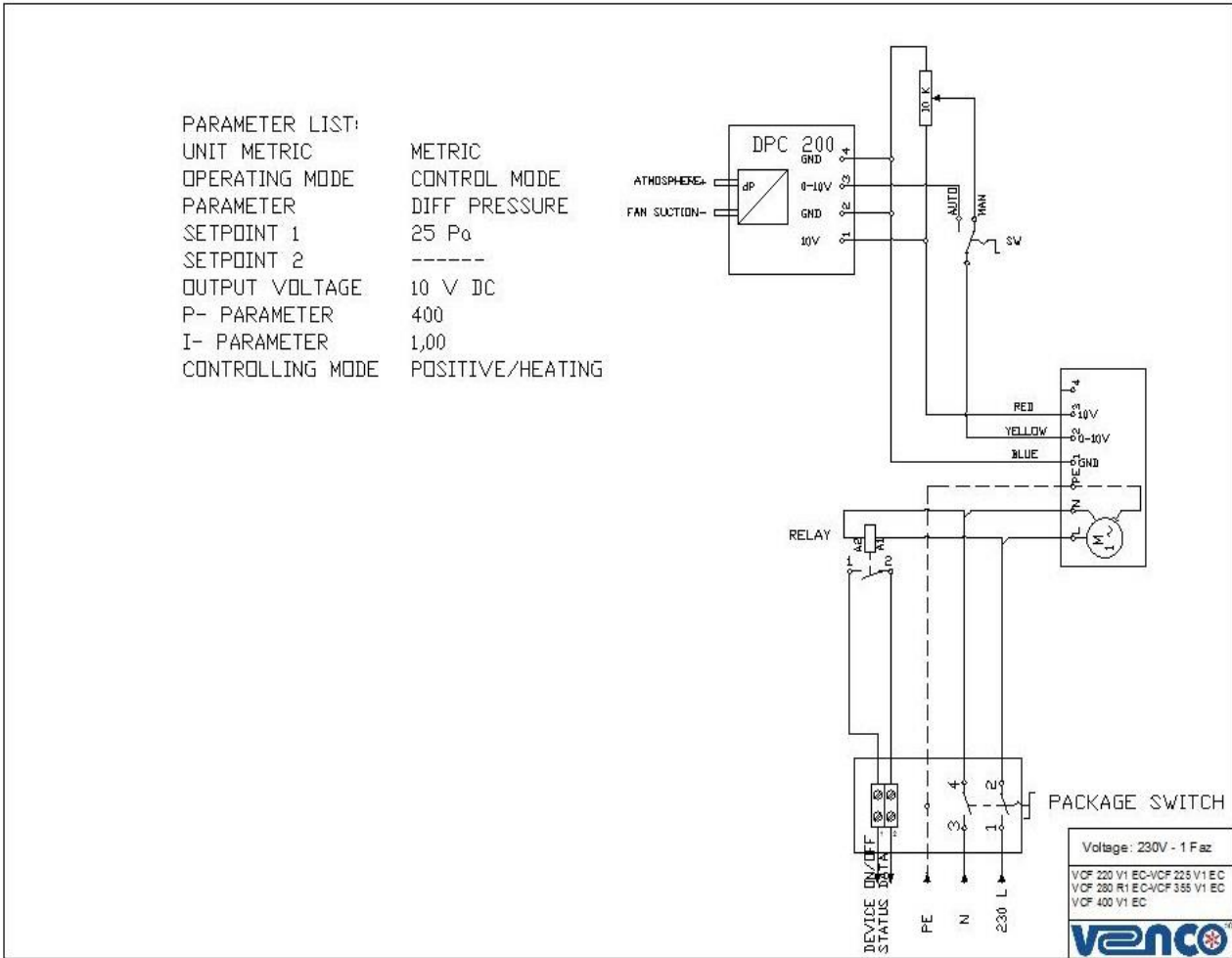



**9.4. Annex-4: 3 Phase EC Electrical Wiring Diagrams**

